

ARCHIGAS



Operating instructions
Gas analyzer
TCD3000 SiA

Contents

1	Preliminary remark.....	2
1.1	Symbols used	2
2	Safety instructions.....	3
3	Conformities	4
3.1	EU directive conformity	4
3.2	Namur recommendation	4
3.3	ATEX and IECEx.....	5
4	Product description	6
4.1	Scope of delivery	6
4.2	Type plate	7
4.3	Area of application.....	7
4.4	Packaging, transport and storage.....	8
5	Assembly.....	9
5.1	Expansion steps	9
6	Electrical connection	10
7	Analogue output.....	11
7.1	Signal mapping for special applications.....	12
8	Serial communication.....	13
8.1	Basic commands.....	14
8.2	Command responses	15
8.3	Device status.....	16
8.4	Command status	17
9	Calibration	18
9.1	Calibration intervals.....	19
9.2	Preparation for calibration.....	19
9.3	Offset calibration	20
9.4	Slope calibration	21
9.5	Substitute gas calibration.....	23
10	Errors and diagnostics	24
11	Maintenance and cleaning	25
11.1	Waste disposal	25
12	Complaints	25
13	Specifications.....	26
14	Measuring components and measuring ranges.....	28
	Appendix A1	29





1 Preliminary remark

These instructions contain all the necessary details for installation, connection and commissioning as well as important information on maintenance, troubleshooting and user safety. Please read these instructions carefully before starting up and keep them as part of the product for easy access at all times.

The operating instructions are intended for trained and qualified personnel and must be made available to them. These operating instructions apply to the following appliance versions:

- **Type:** TCD3000 SiA
- **Hardware-Version G 1/2":** 1000-0000-0011-0002
- **Hardware-Version NPT 1/2":** 1000-0000-0013-0002
- **Firmware version:** Valid from **5.35** please refer to the calibration certificate
- **Manufacturer:** Archigas GmbH
Eisenstrasse 3
65428 Ruesselsheim am Main
Germany

1.1 Symbols used

	Caution, information on potential hazards.
	Additional information and helpful tips.
	Warning! Hot surface - risk of burns! Use protective gloves.
	The appliance is approved for use in potentially explosive atmospheres and fulfils the relevant safety requirements for these zones.
	The CE mark indicates that the appliance complies with the EU directives for safety, health protection and environmental protection.

2 Safety instructions

- **Authorized specialist personnel:** All work on and with the appliance may only be carried out by trained specialist personnel authorized by the system operator.
- **Personal protective equipment:** Always wear appropriate personal protective equipment when working with the device. Although well-made, there is a risk of cuts, so protective gloves are mandatory. Heat protection gloves should be worn due to the possibility of increased surface temperatures. Safety goggles are also mandatory to protect against flying parts due to residual pressure in the line.
- **Proper use:** The device may only be operated as specified in the operating instructions and only for the intended applications and environmental conditions.
- **System responsibility:** When integrated into a system, the system manufacturer is responsible for safety and must prepare a risk assessment and the corresponding documentation.
- **Technical standards:** The appliance complies with current technical standards and regulations and may only be operated in a perfect and safe condition.
- **Property damage and personal injury:** Improper use, incorrect installation or settings can lead to property damage, personal injury or environmental damage.
- **Tamper prevention:** Any actions beyond the operations described may only be performed by authorized manufacturer personnel. Unauthorized modifications are prohibited.
- **Safety markings:** Safety labels and instructions attached to the appliance must be observed.
- **Damage protection:** Devices and cables must be adequately protected against damage.
- **Permitted media:** The appliance may only be used for the media specified in the technical data.
- **Documentation:** These operating instructions must be read before putting the product into operation and retained for the entire service life.

3 Conformities

The device complies with the statutory requirements of the relevant EU directives. The CE marking confirms the conformity of the appliance with these directives.

3.1 EU directive conformity

The declaration of conformity is available for download on the product webpage. The following directives are fulfilled:

- **2014/30/EU (EMC Directive):** Directive on the harmonization of Member States' laws regarding electromagnetic compatibility.
- **2014/35/EU (Low Voltage Directive):** Directive on the harmonization of Member States' laws regarding the availability of electrical equipment intended for use within certain voltage limits.
- **2011/65/EU (RoHS Directive):** Directive on the restriction of hazardous substances in electrical and electronic equipment.

3.2 Namur recommendation

The following recommendations of the NAMUR standardization working group for measurement and control technology in the chemical industry are observed:

- **NE 21:** Electromagnetic compatibility of process and laboratory equipment
- **NE 43:** Signals for transducer faults

3.3 ATEX and IECEx

The TCD3000 SiA gas analyzer is classified as explosion-proof equipment in accordance with Directive 2014/34/EU of the European Parliament and Council, dated 26 February 2014, in compliance with the following standards:

- IEC 60079-0:2017
- EN IEC 60079-0:2018
- IEC/EN 60079-1:2014

Approval and Labelling:  II 2 G Ex db IIC T4/T3 Gb, -40°C < Ta < +90°C/+125°C

EU-Type Examination Certificate: DNV 24 ATEX95061X

IECEx Certificates: IECEx DNV 24.0010X

Product: Gas Analyzer

Manufacturer: Archigas GmbH
Eisenstrasse 3
65428 Ruesselsheim am Main, Germany

This device is designed for use in hazardous areas classified as **Zone 1 and Zone 2** in accordance with ATEX / IECEx requirements.

The device is not approved for use in Zone 0

Special conditions of use:

1. The cable gland is only suitable for fixed installations. Cables shall be effectively clamped to prevent pulling or twisting.
2. The measuring function of the EUT is not covered by this type examination. It shall comply with the requirements from the relevant harmonized standards which provide guidance on the performance of gas detection equipment and safety devices.



Important usage notes:

- The device is supplied with a 3-meter connection cable. This cable must not be shortened in potentially explosive atmospheres unless suitable measures are taken to prevent zone entrainment.
- The housing or parts of the device must remain closed. Opening the device will void the ATEX certification.

4 Product description

The TCD3000 gas analyzer operates on the principle of thermal conductivity. This method is based on the varying abilities of gases to conduct heat. The TCD3000 is equipped with a micromechanical sensor that contains an integrated heat source and a sink. As the gas sample flows through, the temperature difference between the source and the sink is measured, which correlates directly to the gas's thermal conductivity.

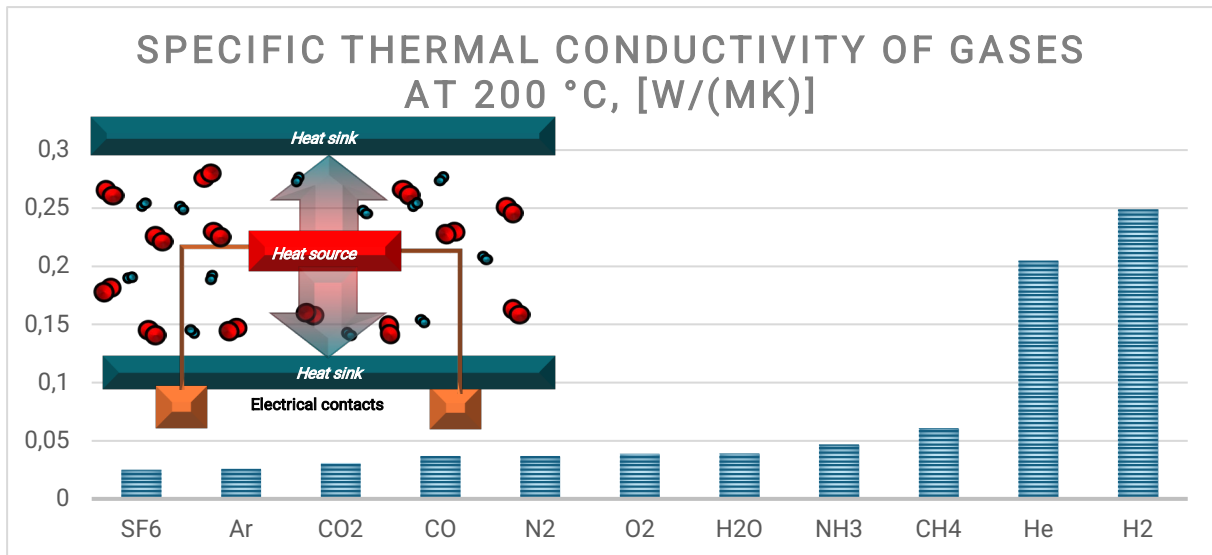

Gases such as hydrogen (H₂) and helium (He), which have the highest thermal conductivity values, can be detected particularly well with the TCD3000. This enables extremely sensitive and accurate determination of their concentrations. The micromechanical sensor offers a fast response time and high precision.

The TCD3000 is suitable for binary gas mixtures consisting of two different gases as well as for quasi-binary gas mixtures. In the case of quasi-binary gas mixtures, the carrier gas either consists of a constant ratio of many gases, such as air, or it is two or more gases with very similar or identical thermal conductivities that are recognized as one gas for the measurement, such as O₂ and H₂O or N₂ and CO.

4.1 Scope of delivery

The delivery scope includes:

- TCD3000 SiA gas analyzer with 3 meter fixed connection cable

Also included in the scope of delivery:

- Operating instructions for the TCD3000 SiA gas analyzer
- Calibration certificate for the gas analyzer
- Further certificates and accessories, if applicable
- USB to RS485 converter

4.2 Type plate

The most important information for identifying and using the device is found on the type plate.



1. Device type
2. Technical details
3. CE labelling
4. QR code - link to the manufacturer's website
5. Ex labelling
6. Manufacturer and place of manufacture
7. Serial number and production year

4.3 Area of application

The TCD3000 SiA is designed for measuring binary and quasi-binary gas mixtures in demanding industrial environments. The most common applications are the monitoring of the lower and upper explosion limits (LEL and UEL) of hydrogen, the control of gas mixtures and the monitoring of gas purity.

The device is suitable for use under high pressure, high humidity, as well as under normal conditions with condensation. It can be used in dynamic areas with very high flow rates as well as in static areas. This enables the device to be used directly within the process without requiring sample preparation.



Refer to the Specifications chapters for the key data for operating ranges.

4.4 Packaging, transport and storage

During transport to the place of use, the device has been secured with protective packaging designed to withstand typical transport stresses. The packaging of the device is made of environmentally friendly cardboard and is recyclable. Please dispose of the packaging material in accordance with local regulations.

Upon receipt of the delivery, an immediate inspection for completeness and possible transport damage is required. Any transport damage or concealed defects found must be dealt with accordingly. The packages should remain sealed and stored according to external installation and storage markings until setup.

Unless otherwise specified, packages should only be stored under the following conditions:

- Do not store outdoors
- Store in a dry and dust-free place
- Do not expose to aggressive media
- Protect from sunlight
- Avoid mechanical shocks
- Storage and transport temperature according to chapter Specifications

5 Assembly

Remove the device from the packaging immediately before installation and inspect it carefully for damage. Before installation, visually inspect the sealing points to ensure the device is secure and in proper condition. A damaged appliance must not be used to ensure the safety and functionality of the system.



Ensure that the system is depressurized before installing or removing the device to prevent injury and damage.



The device may become hot during operation and remain hot for a prolonged period after being turned off. Wear suitable protective gloves to avoid burns when touching or working on the appliance.

Screw the TCD3000 SiA directly onto the process gas line. Use a hexagon spanner with the spanner size specified in the installation drawing to securely fasten the device to the process connection.

Ensure not to rotate the device by the cable gland during installation to avoid damage.

After installation, inspect the device again for any damage and ensure a secure connection.



The device is designed to prevent customer access to internal components. Opening the appliance may jeopardize the warranty and safety standards.

For the mechanical connection, follow the installation instructions in the appendix of the corresponding model:

- TCD3000 SiA: see Appendix A1

5.1 Disassembly

Before dismantling, it is important to pay attention to potentially hazardous process conditions, such as pressure in the tank or pipework, high temperatures or the presence of aggressive or toxic media.



Replacement must only be performed with the device in a de-energized state.

When removing the device, follow the steps in the Assembly and Electrical connection sections in reverse order.

6 Electrical connection

The device may only be installed by qualified personnel. All applicable national and international regulations for electrical installations must be followed.

The analyzer is supplied with a permanently connected, 3 meter long connection cable. In hazardous areas (Ex zones), this cable must not be shortened unless appropriate measures are implemented to prevent zone entrainment. The device is intended for permanent installation.

Before starting work, ensure that the system is de-energized. The supply voltage must comply with SELV (Safety Extra-Low Voltage) or PELV (Protected Extra-Low Voltage) requirements to ensure safe operation.

The TCD3000 SiA fulfils the EMC requirements in accordance with the NAMUR NE21 and EN 61326-1 standards. The device must be correctly grounded to ensure electrical safety and minimize electromagnetic interference. Grounding is achieved through the shield wire, which is connected to the power supply ground.



Do not switch off the device power supply while operating in a humid environment. The power supply must only be switched off when dry measurement gas is present.

For electrical connection details, refer to the relevant appendix for your model:

- TCD3000 SiA: Appendix A1

Grounding Notice

The GND signals of the power supply and the control system (PLC) must be at the same electrical potential, as they are internally bridged and isolated from housing Ground within the device.

If the sensor (via the threaded mounting connection) is at a different electrical potential than the control system, the sensor cable shield must **not** be connected.

If the plant grounding philosophy differs from the configuration described here, the final grounding scheme must be verified and approved by the responsible electrical or instrumentation engineer at the installation site.

Incorrect grounding or wiring may result in:

- unstable measurements
- communication errors
- damage to connected equipment
- malfunction of the analyzer system

7 Analogue output

The 4 - 20 mA output of the TCD3000 SiA is designed according to the NAMUR NE 43 standard, accommodating various diagnostic ranges.

The current output is configured according to the following guidelines. An example measuring range of 0 - 4 vol.% is shown below.

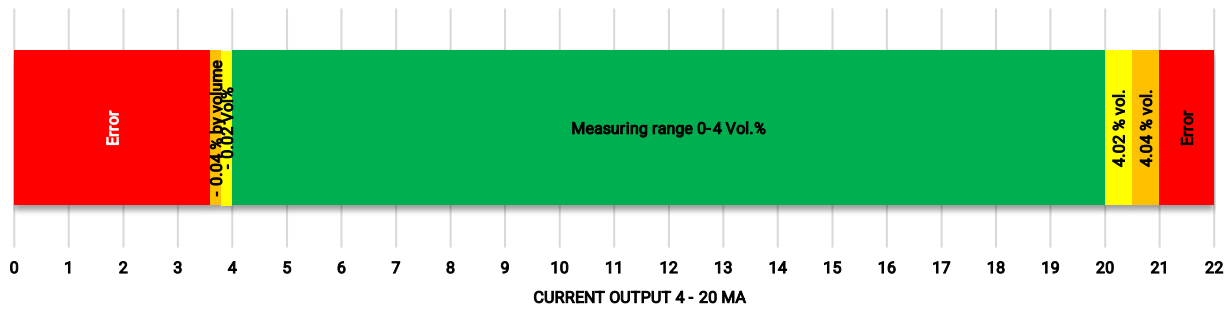

Current range mA	Meaning	Customisation
≤ 3.6	Fatal error / connection error	Output to 3.6 mA
3.6 - 3.8	Low priority Error / maintenance mode	Output to 3.8 mA
3.8 - 4.0	Measuring range undershot	none
4.0 - 20.0	Measuring range	none
20.0 - 20.5	Measuring range exceeded	none
20.5 - 21.0	Low priority Error	Output to 20.5 mA
≥ 21.0	Serious fault / short circuit	Output to 21 mA

7.1 Signal mapping for special applications

In specific applications, the 4-20 mA output can be factory-configured to display negative or positive signal values.

Pressure compensation

The signal may enter the negative or positive range as pressure decreases or increases. To compensate for pressure influence, the signal can be configured as shown in the following diagram:

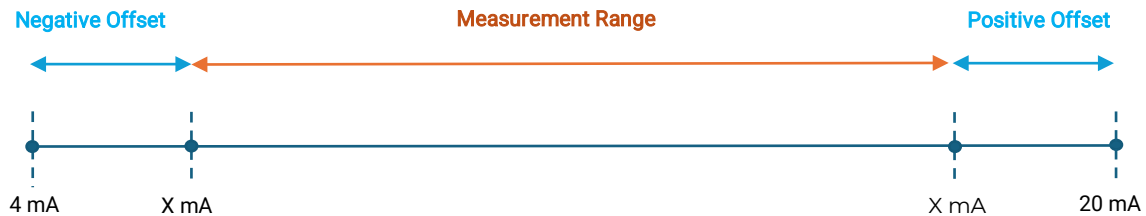

Two measuring ranges with one output

In some cases, a secondary process gas, such as N_2 , may be introduced alongside the main measuring range, such as H_2 in O_2 . Since N_2 has a lower thermal conductivity than O_2 , it results in a negative measured value. This is also used to map this process with the analyzer:

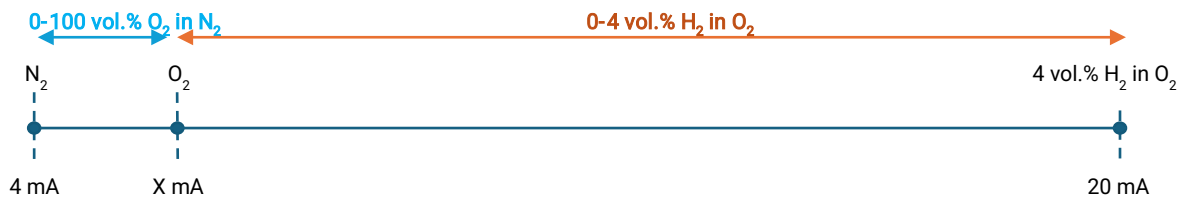

8 Serial communication

With simple commands, the device can be controlled, parameters set, and important information queried. Communication can take place either with a PLC control unit or a computer via a USB/RS485 converter.

The TCD3000 SiA communicates through the RS485 output with a differential voltage of 3.3 V. To establish the connection correctly, the following serial port parameters should be used:

COM port	Current port number
speed	38.400
data	8 bit
Parity	none
Stop bits	1 bit
Flow control	none



If the supplied USB/RS485 converter is not used, communication problems with the sensor cannot be ruled out.

8.1 Basic commands

Each command starts with the device address, which defaults to A, followed by the command. If you want to connect several devices at the same time, please note that you must first assign them different addresses, as all devices are delivered with the address 'A'. Multiple devices with the same address cannot be used at the same time as this will lead to communication problems with the sensors. First connect one device and assign it a different address, for example 'B' using the command ACA@B ("A" change address). After that, you can connect additional devices.

Command	Description and explanation	Example ('A')
<address>?	Requests information about the device, including firm-ware version, serial number and device status.	A?
<address>!	Requests the device to send the current measurement data.	A!
<address>LA@<password>	Administrator login. Grants access to advanced configuration and management rights. The default administrator password is 119977.	ALA@119977
<address>LU@<password>	User login. Switches to user mode, allowing only measured values to be accessed.	ALU@123
<address>CP@<new password>	Changes the device password to the specified new password. The password consists of six digits (0-9). Administrator access required.	ACP@123456
<address>CA@<address A-Z>	Changes the device address to the specified new address. Administrator access required.	ACA@B
<address>CR@<value 1-10>	Switches between preset measuring ranges. Up to ten measuring ranges can be defined. Administrator access required.	ACR@3
<address>C4mA@<value>	Changes the measuring range to a 4 mA standard value that corresponds to a specific range value in ppm. Administrator access required.	AC4mA@0
<address>C20mA@<value>	Changes the measuring range to a 20 mA standard value that corresponds to a specific range value in ppm. Administrator access required.	AC20mA@40000
<address>MA	Sets the analyzer to maintenance mode, in which the device is put into or taken out of maintenance mode.	AMA
<address>O@<value>	Starts the offset calibration and sets the calibration gas (value in ppm) for the calibration. Administrator access required.	AO@0
<address>SA@<value>	Starts the calibration of the measuring span and sets the calibration point A to the desired value in ppm. Administrator access required.	ASA@0
<address>SB@<value>	Starts the calibration of the measuring span and sets the calibration point B to the desired value in ppm. Administrator access required.	ASB@40000

<address>SOS!	Saves the current device operation settings, including the address, calibration, measuring range, analogue output, and password. Each new save replaces the previous one.	ASOS!
<address>ROS!	Restores the operation settings.	AROS!
<address>RFS!	This resets the device to the factory settings	ARFS!

8.2 Command responses

After powering on, restarting the device, or entering the command **<address>?** or **<address>LA@<password>** or **<address>LU@<password>** or **<address>CA@<A-Z>**, the following information is displayed:

A	Device address
199	Serial number
526	Firmware version
240804	Parameter version
240101	Date of manufacture YYMMDD
123	Operating hours
1	Calibration curve
0	Begin of measuring range
1000000	End of measuring range
0x0001	Device status
0x01	Command status

Example:

A; 199; 526; 240804; 240101; 123; 1; 0; 1000000; 0x0001; 0x01

For all other commands, the device displays the following information:

A	Device address
199	Serial number
600.000	Measured value in millivolts
0.00	Concentration in ppm
4.000	Current output value in mA
0x0001	Device status
0x01	Command status

Example:

A; 199; 600.000; 0.00; 4.000; 0x0001; 0x01

8.3 Device status

A status consists of four registers that describe the current status of the analyzer in hexadecimal form. A status register can contain several bits and, depending on the status of the device, several status bits can be set simultaneously. This means that the analyzer can have several statuses at the same time.

Status register	Description
X001	The analyzer is in user mode. The measured values can only be called up, changes to the configuration are not possible.
X010	The analyzer is in administrator mode. Advanced functions such as calibration and configuration are activated. Access is automatically cancelled after one hour or after a restart.
X100	The analyzer is in expert mode. All management and configuration functions are available. This mode is only accessible to the manufacturer.
0XXX	The analyzer is ready for operation. There are no errors or restrictions and the device can perform measurements.
1XXX	The analyzer is in maintenance mode. A calibration is being carried out or is in preparation. Normal operation is restricted during this time. The current output is set to 3.8 mA as standard.
2XXX	The analyzer indicates that it is outside the permissible measuring range. The measurements may be inaccurate and the measuring range may need to be calibrated or adjusted.
4XXX	The analyzer is in an alarm state, indicating that the current concentration has exceeded the limit defined by the measurement range. In this state, an alarm value of 21 mA is output on the analog output.
8XXX	The analyzer signals an error state. The device is either in the warm-up phase or there is an issue that needs to be checked or serviced before it can be put back into operation. In this state, the analog signal shows 3.6 mA.

Examples:

- If the analyzer is in user mode (0x0001) and simultaneously in an error state (0x8XXX), the status code is displayed as the sum of these two values: 0x8001.
- If the analyzer is in maintenance mode (0x1XXX) and administrator mode (0x0010) and the measurement is not yet within the desired range (0x4XXX), the combined status is 0x5010.
- If two faults occur simultaneously and their combined fault value exceeds 10 (for example, faults 2XXX and 8XXX), the device continues the fault code sequence alphabetically, starting with AXXX.

8.4 Command status

The command status register shows the current status of the execution of a command in hexadecimal form. No combinations of status codes can occur, as each command only has one unique status feedback.

Status register	Description
01	The command was executed successfully. No errors occurred and the desired operation was completed.
02	The command was rejected. The user does not have sufficient rights to execute the command.
03	There was an error executing the command. The command could not be processed.
04	The command was rejected. The parameter entered is outside the permitted value range and the command could therefore not be processed.
05	The command was not executed. No suitable command was found in the command list, possibly due to an incorrect entry.
06	The calibration was cancelled. The deviation between the measured value and the calibration gas was too large, or the calibration point is undefined.

9 Calibration

Calibrating the measuring device is essential for ensuring accurate and reliable measurements. This chapter guides you through the various calibration procedures and provides detailed instructions on how to carry them out.

Calibration must only be performed by qualified personnel. Unauthorized modifications or improper handling may result in inaccurate measurement results.

The individual calibration procedures are explained in detail in the following sections of this chapter:

- **9.1 Calibration intervals:** Recommendations for the frequency of calibration based on your application.
- **9.2 Preparation for calibration:** Steps for preparing your device and the required materials.
- **9.3 Offset calibration:** Instructions for correcting systematic deviations.
- **9.4 Slope calibration:** Procedure for ensuring linear proportionality over the entire measuring range.
- **9.5 Substitute gas calibration:** Procedure if an alternative calibration gas is used.

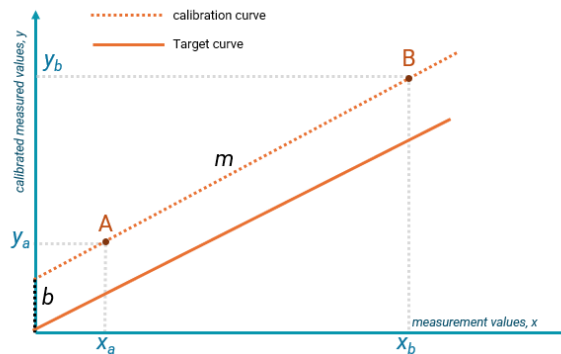

During calibration, a processed measured value is available that can be corrected directly with a linear function:

$$y = m \cdot x + b$$

This means:

- y : the calibrated measured concentration value,
- m : the gradient of the calibration line,
- x : Measured value,
- b : represents the shift of the measured value along the Y-axis (also called offset).

The Archigas devices store the calibration points A (x_a, y_a) and B (x_b, y_b) instead of storing the slope m and the offset b directly. The device uses these points to dynamically calculate the slope m and the offset b for each measurement.

The offset calibration and the slope calibration can be performed independently of each other and in any order without affecting the accuracy of the results. An interruption of the calibration process, including power failures occurring between the offset and slope calibration steps, does not compromise the calibration.

All calibration points are permanently stored in non-volatile memory. This ensures that the calibration procedure can be resumed seamlessly after an interruption without any loss of data.

The factory calibration is stored separately from the customer calibration. At any time, the customer can revert the device to the original factory calibration settings.

9.1 Calibration intervals

The frequency of calibration depends on the measuring range. The smaller the measuring range, the more frequently a calibration should be carried out to ensure measuring accuracy.

For standard applications, such as measuring 0-4 vol.% hydrogen in oxygen, calibration is recommended every 6 months. However, experience has shown that the device becomes more stable after the first 6 months of operation, so the calibration intervals can often be extended. You can adjust these intervals depending on the stability and requirements of your process.

Offset calibration should always be carried out after commissioning the device in order to correct systematic deviations at the zero point. Regular offset calibration is important, especially if precise measurement results are required in the low concentration range.

Slope calibration should only be considered if a significant error is detected in the proportionality of measurement values over the entire range or if an application-specific adjustment of the value is necessary. As the device is generally very stable, the slope of the calibration line remains unchanged even over long periods of time. Slope calibrations are therefore rarely necessary.

9.2 Preparation for calibration

When calibrating a measuring device, it is essential to ensure the correct calibration gases are used. Both the sample gas and the background gas must meet the calibration requirements. The calibration gas must precisely match the device settings. For instance, a device configured for H₂ in O₂ must not be calibrated with H₂ in N₂ unless a substitute gas calibration is applied (see description below).

Before calibrating, check the information in the calibration certificates to ensure that the correct gases are used. Pay attention to whether special conditions or restrictions for the calibration are noted there.

During calibration, set the device to maintenance mode to prevent false alarms in the system. In maintenance mode, the analogue output is set to 3.8 mA. This prevents the system from recognizing a fault due to the calibration.

After introducing the calibration gas, ensure the gas signal is stable. This may take a different amount of time depending on the pneumatic connection and the volume of the system.



Ensure that no dangerous concentrations of the sample gas are created in the system during calibration and that no high pressure is released into the environment.

Calibration shall be performed under ambient pressure conditions unless otherwise specified in the calibration certificate. Calibration under different pressure conditions may lead to deviations in the measurement results.

9.3 Offset calibration

Offset calibration corrects systematic deviations by adjusting all measurement values uniformly. This ensures that the deviation is corrected at a fixed point, uniformly affecting the entire measuring range. The calibration point can be freely selected within the entire measuring range.

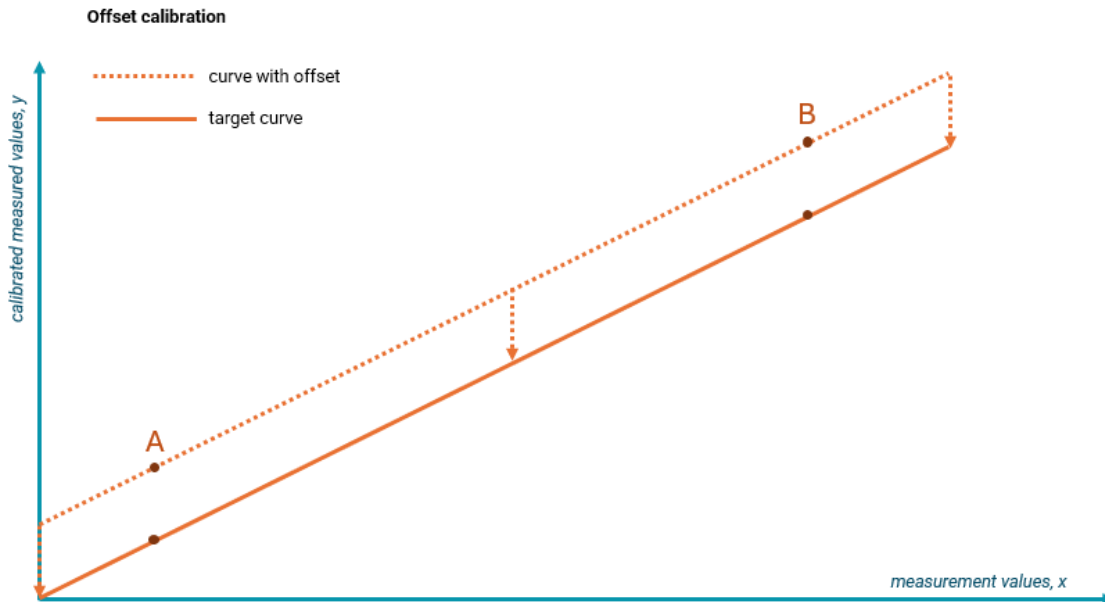

Instructions for performing the offset calibration

1. Default setting
 - Ensure you are logged in as an administrator and that the device is in maintenance mode.
 - If you are not logged in as an administrator, log in with the corresponding command (e.g. ALA@119977). If the device is not in maintenance mode, activate it with the AMA command.
2. Supply calibration gas
 - Add a calibration gas with a known concentration.
 - Example: 2 % by volume H₂ in O₂.
3. Record stable measured value
 - Wait until the device displays a stable measured value ($\leq \pm 1\%$ of the measurement range). Example: Stable measured value of 1.8% by volume.
4. Send offset calibration command
 - Issue the offset calibration command using the calibration gas concentration: AO@20000 (for 20,000 ppm; the number 20000 corresponds to 2.0 vol.%).
5. Check feedback
 - Check the displayed concentration value, the device status and the command status.
6. Exit maintenance mode
 - If no further steps are required, deactivate maintenance mode: AMA.

9.4 Slope calibration

Slope calibration ensures linear proportionality of measurement values across the entire measuring range. Typically, it is rarely required, as the device operates stably and retains calibration over extended periods.

However, slope calibration may be necessary if the application conditions differ from the factory-calibrated values. Depending on the circumstances, point A, point B, or both points may require calibration. The device allows calibration points to be set either within or outside the measuring range and at any distance from each other. However, incorrect selection of calibration points can lead to improper calibration of the device. It is recommended to set the calibration points close to the beginning and end of the measuring range.

Application examples:

- Hydrogen in natural gas: The device was calibrated in the laboratory for hydrogen (H_2) in methane (CH_4). As natural gas has a different composition than methane, it makes sense to carry out the calibration at point A with natural gas in order to obtain accurate measurement results.
- Hydrogen in humid air: The device was calibrated in the laboratory for H_2 in dry, synthetic air. As humid air has different properties to dry air, it is worth calibrating at point A with a constant moisture content in order to compensate for deviations.
- Deviating pressure: If the pressure of the sample gas deviates from the pressure calibrated by the manufacturer, a recalibration can be carried out at points A and B at the current pressure. The prerequisite is that this pressure remains constant; otherwise, dynamic pressure compensation should be used.

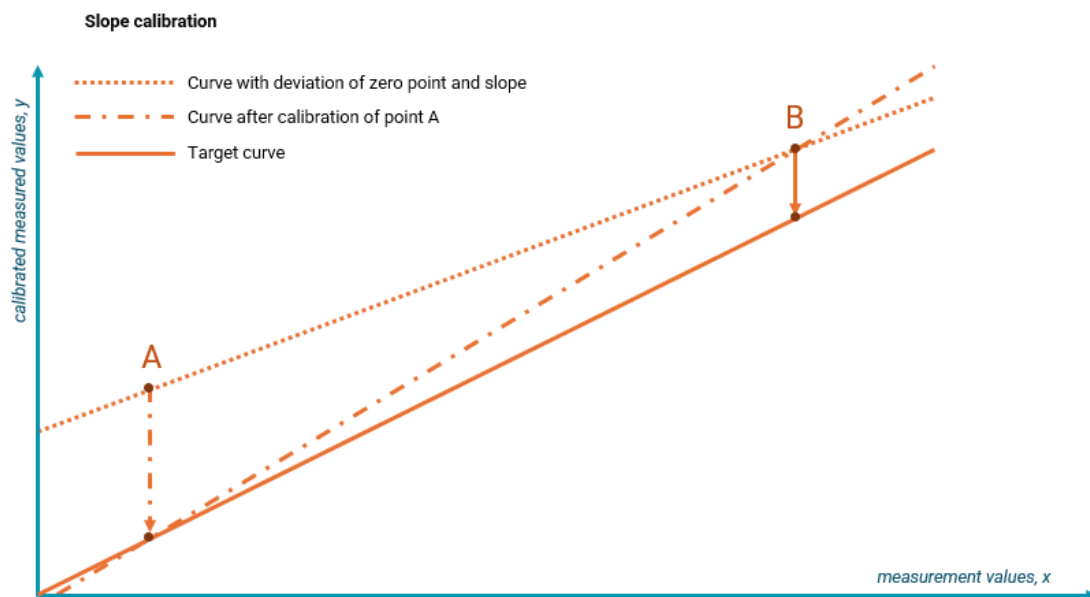

Instructions for performing the slope calibration:

1. Default setting
 - Ensure you are logged in as an administrator and that the device is in maintenance mode. You can read both pieces of information from the device status.
 - If you are not logged in as an administrator, log in with the corresponding command (e.g. ALA@119977). If the device is not in maintenance mode, activate it with the AMA command.
2. Supply the first calibration gas (point A)
 - Add a calibration gas with a known concentration.
 - Example: 0.0 vol.% H₂ in O₂.
3. Record stable measured value
 - Wait until the device displays a stable measured value ($\leq \pm 1\%$ of the measurement range). Example: Stable measured value of 0.3 % by volume.
4. Send calibration command for point A
 - Issue the calibration command using the actual concentration of the calibration gas: ASA@0 (for 0 % by volume H₂).
5. Check feedback
 - Check the displayed concentration value, the device status and the command status.
6. Supply second calibration gas (point B)
 - Add another calibration gas with a known concentration.
 - Example: 4 vol.% H₂ in O₂.
7. Record stable measured value
 - Wait until the device displays a stable measured value ($\leq \pm 1\%$ of the measurement range). Example: Stable measured value of 4.7 vol.%.
8. Send calibration command for point B
 - Send the calibration command with the actual concentration of the second calibration gas: ASB@40000 (for 4 vol.% H₂; the number 40000 corresponds to 4.0 vol.%).
9. Check feedback
 - Check the displayed concentration value, the device status and the command status.
10. Exit maintenance mode
 - If no further steps are needed, exit maintenance mode: AMA.

9.5 Substitute gas calibration

The measuring device can be calibrated with a different gas than originally intended. This is called substitute gas calibration. This requires that the exact equivalent value for the substitute gas is known.

To ensure the correct calibration gas is used, specify the desired calibration gas when ordering the device. The selected value is documented in the calibration certificate so that the device can be calibrated correctly.

Procedure for substitute gas calibration:

1. Checking and preparing the device status
 - Ensure you are logged in as an administrator and that the device is in maintenance mode.
 - If you are not logged in as an administrator, log in with the corresponding command (e.g. ALA@119977). If the device is not in maintenance mode, activate it with the AMA command.
2. Supply replacement calibration gas
 - Add the replacement calibration gas with a known concentration.
3. Determine substitute gas and equivalent value
 - Example: The device is configured for 0–4 vol.% H₂ in O₂. The substitute gas is 5 vol.% H₂ in N₂, which according to the calibration certificate corresponds to an equivalent of 3.8 vol.% H₂ in O₂. This conversion must be taken from the calibration certificate.
4. Record stable measured value
 - Wait until the device displays a stable measured value ($\leq \pm 1\%$ of the measurement range). Example: Stable measured value of 3.7 vol.% H₂ in O₂.
5. Send calibration command with equivalence concentration
 - Issue the substitute gas calibration command with the equivalent concentration: Based on the calibration certificate, send e.g. AO@38000 for 3.8 vol.% H₂ in O₂.
6. Check feedback
 - Check the concentration value, the device status and the command status.
7. Exit maintenance mode
 - If no further steps are needed, exit maintenance mode: AMA.

10 Errors and diagnostics

The following table will help you quickly identify and resolve issues.

<i>Error</i>	<i>Possible cause</i>	<i>Diagnosis and solution</i>
<i>No signal</i>	No power to the device or faulty power supply	Verify the power supply and cabling. Ensure the device is properly connected and powered on.
<i>Unstable or fluctuating measured values</i>	Contaminated sensor or fluctuating process conditions	Clean the sensor as per the maintenance instructions. Verify process conditions, such as pressure, to ensure stability.
<i>Measured value deviates greatly</i>	Incorrect calibration or unaccounted pressure and humidity influences	Verify calibration and recalibrate if necessary. Ensure pressure and humidity corrections are applied accurately.
<i>Display of an error</i>	Internal fault in the device or defective sensor	Contact technical support.
<i>No or weak signal at the analogue output</i>	Incorrect analogue output configuration or faulty output	Verify the analogue output configuration for accuracy. Test the output with a multimeter to ensure proper function.
<i>Communication via RS485 not possible</i>	Incorrect settings or cabling problems	Check the RS485 settings (baud rate, parity, etc.) and ensure that they are correct. Check the cabling and ensure that all connections are tight and correct.
<i>Calibration fails</i>	Unstable measurement conditions or incorrect calibration gas	Make sure that the measurement conditions are stable and that the correct calibration gas is used. Repeat the calibration as instructed.

If none of the above diagnostic and solution steps solve the problem, please contact Archigas GmbH technical support at support@archigas.com. Please have all relevant information and error messages ready to ensure fast and efficient support.

11 Maintenance and cleaning



Cleaning with liquids may only be performed while the sensor is powered on. Otherwise, the sensor may sustain permanent damage.

Under challenging conditions (e.g., particulate contamination in the process gas), regular visual inspection of the sintered metal filter is recommended. To clean the filter, immerse the device in water up to the type plate, ensuring the process gas opening is submerged.

Cleaning the housing helps to ensure that the rating plate and markings on the appliance remain visible. Please note the following:



Opening the device for repair or cleaning is prohibited.

Avoid aggressive cleaning agents that may damage the housing, seals, or cable. Only use suitable cleaning methods.

11.1 Waste disposal

For device disposal, contact the manufacturer. Typically, the TCD3000 SiA is accepted by the manufacturer for recycling and disposal.

12 Complaints

Do not return devices without prior authorization. Please contact us first.

If a repair is necessary, please proceed as follows:

- Request an RMA form from us and complete it for each device.
- Specify any existing contamination.
- Package the device securely for transport.
- Send the device with the completed form to the manufacturer's address (see chapter "Preliminary remark").

13 Specifications

General technical data	
Installation position	independent
Weight	approx. 750 g
Dimensions	NPT: Ø45 x 116 mm G: Ø45 x 112 mm
Protection class	IP66 / IP68 according to EN 60529
Gas connection	G ½ inch or NPT ½ inch
Electrical features	
EMC immunity	NAMUR NE21 (05/2006) / EN 61326-1 (2013)
Electrical safety	EN 61010-1:2010
Management	Cable diameter: Ø 7.7 mm Wire cross-section: max. 7 x 0.75 mm ² Bend radius: 38.5 mm
Electrical inputs and outputs	
Power supply	24 ±25% VDC, < 5 W
Analogue output	4-20 mA potential-bound, RL ≤ 750 Ω
Serial interface	RS485, baud rate 38400 / data 8 bit
Measuring ranges	
Number of measuring ranges	10; freely parameterizable
Smallest possible measuring span	0.5 vol.% H2 in air, oxygen, or nitrogen
Largest possible measuring span	100 vol.% H2 in air, oxygen, or nitrogen
Smallest possible measuring span with suppressed zero point	2 vol.% H2 in air, oxygen, or nitrogen
Gas inlet conditions	
Process gas pressure	0.9 to 200 Bar (absolute)
Process gas flow	0 to 10 m/s (higher flow rates on request)
Process gas temperature	-40 to +125°C
Process gas humidity	up to 100 % RH (moisture content may result in measurement errors)
Time behavior	
Warm-up time	< 1 min
Reaction time	30 ms
T90 Time	< 1 s
Measuring behavior*	
Noise	< 10 ppm
Detection limit	< 50 ppm
Measured value drift	< 100 ppm / week
Repeatability	< 100 ppm
Linearity deviation	< 1 % of the current measuring span
Influencing variables*	
Ambient temperature	< 50 ppm / 10K
Process gas pressure at zero point	< 25 ppm / 10 hPa; from 1 MPa < 2 ppm / 10 hPa

<i>Process gas pressure for deflection gas</i>	< 100 ppm / 10 hPa; from 1 MPa < 10 ppm / 10 hPa
<i>Process gas flow at zero point</i>	< 25 ppm / m/s
<i>Process gas flow rate with deflection gas</i>	< 100 ppm / m/s
<i>Accompanying gases</i>	The cross-gas sensitivity depends on the application and must be determined on a case-by-case basis.
<i>Climatic conditions</i>	
<i>Storage and transport</i>	-40 to +90 °C
<i>Ambient temperature</i>	-40 to +90 °C
<i>Ambient humidity</i>	up to 100 % RH
<i>Parts in contact with sample gas</i>	
<i>Screw-in housing</i>	Stainless steel 316L
<i>Sintered metal filter</i>	Stainless steel 316L
<i>Sensor</i>	Si, SxNy, epoxy encapsulation, ceramic, Al
<i>Gasket</i>	FKM

**As example for 0.5 vol.% H₂ in N₂*

14 Measuring components and measuring ranges

Sample gas	Carrier gas	Basic range	Smallest range
Hydrogen (H ₂)	Nitrogen (N ₂) or Air	0% – 100%	0% – 0.5%
Oxygen (O ₂)	Nitrogen (N ₂)	0% – 100%	0% – 15%
Helium (He)	Nitrogen (N ₂) or Air	0% – 100%	0% – 0.8%
Carbon dioxide (CO ₂)	Nitrogen (N ₂) or Air	0% – 100%	0% – 3%
Nitrogen (N ₂)	Argon (Ar)	0% – 100%	0% – 3%
Oxygen (O ₂)	Argon (Ar)	0% – 100%	0% – 2%
Hydrogen (H ₂)	Argon (Ar)	0% – 100%	0% – 0.5%
Helium (He)	Argon (Ar)	0% – 100%	0% – 0.5%
Carbon dioxide (CO ₂)	Argon (Ar)	0% – 60%	0% – 10%
Argon (Ar)	Carbon dioxide (CO ₂)	40% – 100%	–
Methane (CH ₄)	Nitrogen (N ₂) or Air	0% – 100%	0% – 2%
Methane (CH ₄)	Argon (Ar)	0% – 100%	0% – 1.5%
Argon (Ar)	Oxygen (O ₂)	0% – 100%	0% – 3%
Nitrogen (N ₂)	Hydrogen (H ₂)	0% – 100%	0% – 2%
Oxygen (O ₂)	Carbon dioxide (CO ₂)	0% – 100%	0% – 3%
Hydrogen (H ₂)	Helium (He)	20% – 100%	-
Hydrogen (H ₂)	Methane (CH ₄)	0% – 100%	0% – 0.5%
Hydrogen (H ₂)	Carbon dioxide (CO ₂)	0% – 100%	0% – 0.5%
Sulfur hexafluoride (SF ₆)	Nitrogen (N ₂) or Air	0% – 100%	0% – 2%
Nitrogen dioxide (NO ₂)	Nitrogen (N ₂) or Air	0% – 100%	0% – 5%
Hydrogen (H ₂)	Oxygen (O ₂)	0% – 100%	0% – 0.5%
Argon (Ar)	Xenon (Xe)	0% – 100%	0% – 3%
Neon (Ne)	Argon (Ar)	0% – 100%	0% – 1.5%
Krypton (Kr)	Argon (Ar)	0% – 100%	0% – 2%
Extinguishing gas (R125)	Nitrogen (N ₂) or Air	0% – 100%	0% – 5%
Deuterium (D ₂)	Nitrogen (N ₂) or Air	0% – 100%	0% – 0.5%
Deuterium (D ₂)	Helium (He)	0% – 100%	0% – 5%

Appendix A1

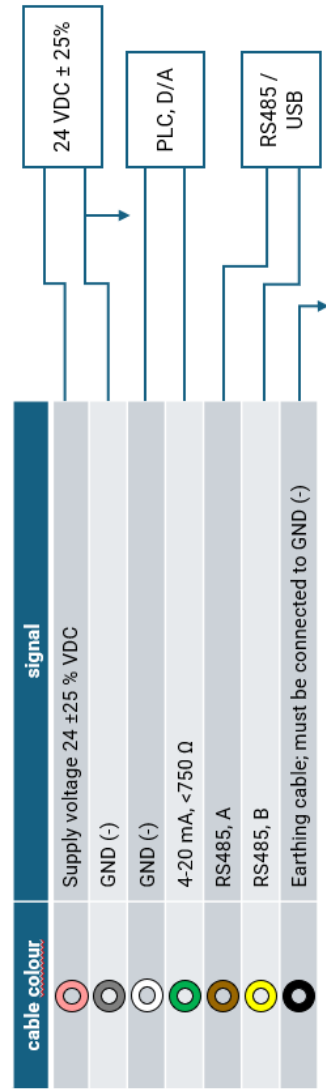

During device installation, ensure that the cable is not twisted.
 After installation, the cable must be permanently secured to prevent twisting and to guarantee strain relief.

Improper installation may compromise explosion protection.

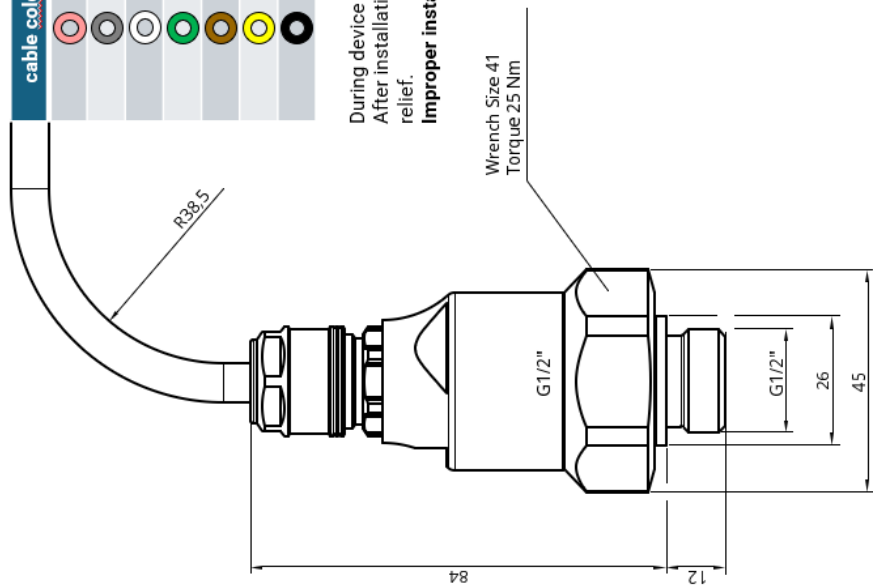

Hardware-Version G 1/2"
 1000-0000-0011-0002

Hardware-Version NPT 1/2"
 1000-0000-0013-0002